

nVENTIV Mach II Service Manual



**Service Manual
Version 1.0**

Introduction.....	3
Background.....	3
Vapor Compression Refrigeration	3
System Overview	4
Mounting the EasyMod Kit for Intel CPUs.....	6
Mounting the EasyMod Kit for AMD CPUs.	8
Mounting the Microfreezer.	10
Improving Thermal Contact.....	11
Connecting the Wires	12
Installing the Software.....	15
Installing the Prometeia USB driver.....	15
Installing the Prometeia Control Centre.	16
ADD-ON PRODUCTS.....	18
Mounting the PC -Top chassis.....	18
Installing the Aluminium kit.	19
Explode view	20
Installing the Display	21
Troubleshooting	23
Error code.....	23
Problems	24
FAQ	25
Appendix A.....	28
TECHNICAL SPECIFICATIONS	29
Contact information.....	29

Introduction

The potential for low temperature enhancement of CMOS performance has been recognized for some time, going back as far as the late 1960's and mid-1970. A lot of articles have been written with the focus on low temperature electronics and the advantages of operating electronics at low temperatures.

Among the advantages are faster switching times of semiconductor devices, increased circuit speed due to lower electrical resistance of interconnecting materials, and a reduction in thermally induced failures of devices and components.

Background

The primary desire for driving CMOS chip technologies to lower temperatures is increased performance.

A chip comprised of CMOS transistors typically increases its operation speed by approximately 0,35% per °C drops in chip temperature.

Using vapor compression refrigeration cycle, 100°C temperature improvement in chip temperature is not unrealistic, resulting in 35% improvement in system performance.

Vapor Compression Refrigeration

Heat is introduced to the system by the device being cooled. This heat vaporizes liquid refrigerant in the evaporator. This vapor is subsequently carried through the suction tube to the compressor. Work is supplied to compress the warm vapor into a hot, high-pressure vapor that is passed to the condenser.

The hot high-pressure vapor releases its heat to the air stream across the condenser fins as it condenses into a warm liquid. Warm liquid is pumped from the bottom of the condenser through the capillary tube where its pressure and temperature drop significantly, creating the refrigeration effect. The cycle completes as the cold fluid passes to the evaporator.

Vapor compression refrigeration cycle offers several advantages for electronic cooling applications. Vapor compression systems can reject heat far from the source by separating the evaporator and condenser in a so-called "split system". Vapor compression refrigeration transports large quantities of heat with a small mass of circulating fluid. This is an advantage over a chilled fluid loop that requires a much higher mass flow rate of coolant.

Vapor compression can produce -40°C evaporating temperatures using common food storage and cooling refrigerants.

System Overview

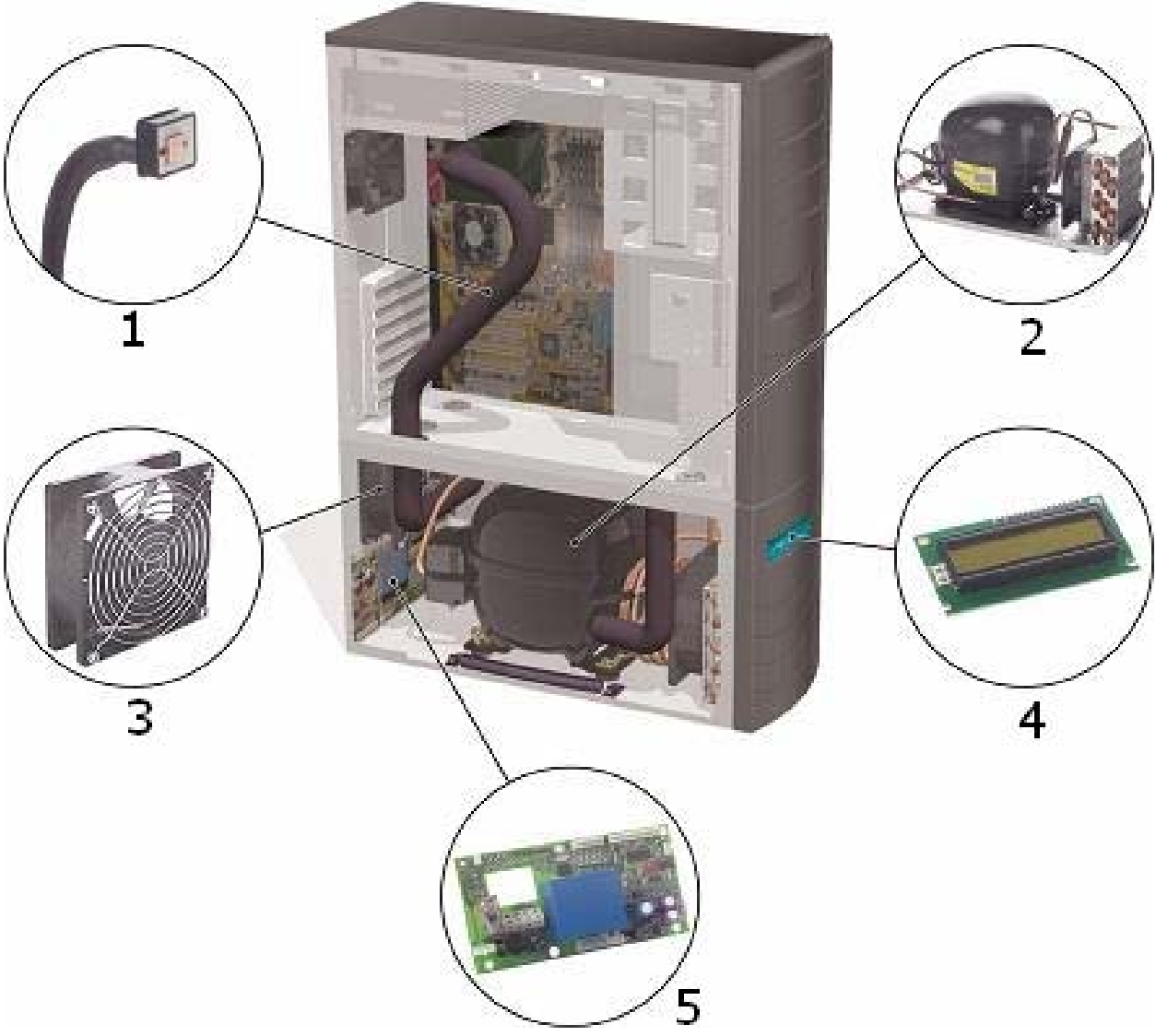

1) Micro Freezer and the Thermal Bus.

The Micro Freezer is via the EasyMod CPU kit connected to the motherboard/CPU.

The Micro freezer hosts the evaporator (the cold plate) that cools the CPU.

The evaporator - located inside the Micro freezer, is placed directly on the processor where the two surfaces mate each other. Heat is extracted directly from the surface of the CPU which will cause the refrigerant inside the evaporator to be vaporized. The vaporized refrigerant is transported to the condensing unit via the thermal bus and the compressor.

The Thermal Bus consists of a suction tube and the capillary tube (inlet tube).

The evaporator is connected to the compressor via the suction tube and to the condenser via the capillary tube. The cold refrigerant is led to the evaporator from the condenser through the capillary tube.

2) Compressor and the Condenser

The compressor maintains a constant pressure gradient between the evaporator (low pressure/low temperature) and the condenser (high pressure/high temperature).

Energy introduced to the cold refrigerant in the evaporator is "moved" by the compressor to the condenser. The refrigerant compressed to the condenser as a hot high pressured vapor.

The hot high-pressured vapor releases its heat to the air stream across the condenser fins as it condenses into a warm liquid.

3) Fans

The Panaflo fans are used to maintain airflow through the cooling system, to prevent the system from overheating and to cool down the condenser, thereby obtaining lower condensing pressure. A lower condensing pressure causes a lower pressure in the evaporator and thereby obtains lower evaporating temperature.

The fans are based on the Panasonic's Hyperflow Technology creating a high airflow and a low non-pitching noise level.

4) Display

There are 2 modes in the optional Display Kit.

The first is a system mode where you can only see the evaporator temperature or error messages if an error should occur.

The second is the user mode, where the User Interface, can display almost any text in the display.

5) Chip-controller

The Chip-controller is used to communicate with the PC and handles all system parameters.

It controls the fan speed, display text, alarm settings, heating elements and boot procedure.

The Windows user interface can, via the USB channel, be used to change or monitor the system settings from the Chip-controller.

It is also possible to upgrade the firmware in the Chip-controller so that new features can be added later on.

Mounting the EasyMod Kit for Intel CPUs

To ensure proper operation please follow these instructions carefully. It is important that the instructions are carried out exactly as described and shown on the illustrations.

Mount the heating element inside the Rear cover. The heating element is self-adhesive, so remember to take off the protective paper protecting the glue before installing it. Place some seal string on the edge of the rear cover where the wires come out, before sealing the entire edge. This prevents any gap from forming between the wires and the rear cover.

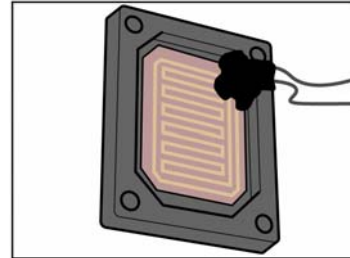

Place seal-string onto the perimeter of the rear cover.

Use 2 of the 4 cover screws as guides in diagonally opposite holes around the CPU socket, firmly press the rear cover onto the back of the motherboard. If the cover is resting on any SMD components, make sure that the entire SMD component and the area around it is also covered in seal string.

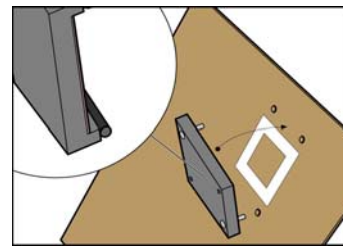

Install the CPU in the socket. Place the metal clips in the upper asymmetric bracket, note that the clips has 2 asymmetric positioned threaded brass stands.

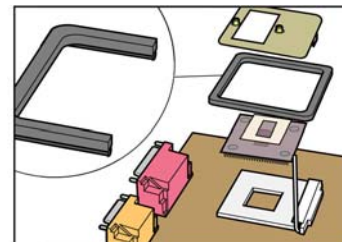

The outermost brass stand must always point either towards the rear or the bottom of the motherboard, but the mounting bracket may turn either way. This way you can shift the position of the hole over the CPU Core for the best fit.

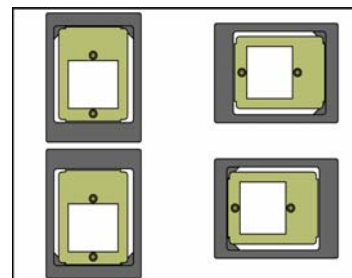

NOTE: The temperature of the CPU core does not have an effect on, that the evaporator does not cover the heat spreader 100%. The evaporator will always cover the CPU core 100% and thereby cool the CPU core to lowest possible temperature.

Place **2** layer of seal-string on the inside perimeter on the bottom of the upper bracket and place it around the CPU socket so that the 2 guide screws fits the holes in the upper bracket.

Place the last two screws into the holes in the rear cover, and 'cross'-tighten all 4 screws so that both the rear cover and upper mounting bracket is firmly pressed against the motherboard.



Important: Place extra seal string around all components that are caught going in under the bracket, to prevent any false air to find its way underneath such components into the hermetic sealed chamber.

Install the motherboard on the PC-mounting metal plate and assemble it inside the PC-chassis.

Make sure that the stands on the back plate are located correctly when mounting the motherboard to the back plate.

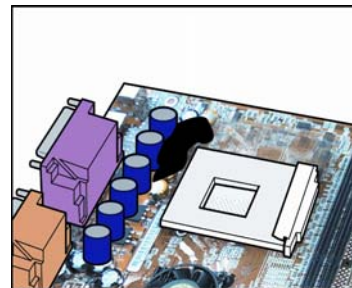

Mounting the EasyMod Kit for AMD CPUs.

To ensure proper operation, please follow these instructions carefully. It is important that the instructions are carried out exactly as described and shown on the illustrations.

Install the CPU in the socket and place a shim plate which protects the CPU when mounting the micro freezer. Make sure that the shim plate does not interfere with any SMD components that are located around the CPU, otherwise make a cut-out in the shim plate, ensuring the shim plate is placed correctly. Remember to peel off the brown paper that protects the adhesive side of the shim plate.

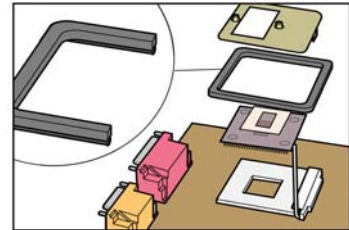

Mount the clips on the socket by pressing the stands towards each other in order to "open" the clips slightly, making it easier to slide it over the socket taps. The clips should be oriented so the opening is centered over the CPU – this makes sure that the micro freezer is mounted correctly.

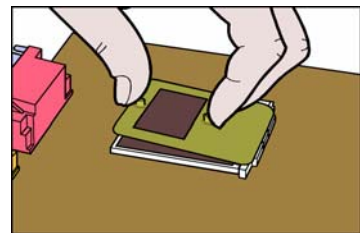

The upper bracket has thin 2.5mm legs on the bottom of the upper bracket. This allows the bracket to stand straight on the motherboard, even if a few small components are located around the socket underneath the bracket. In case one or more of the support legs conflict with such a component, just cut off that leg with a sharp knife. **Make sure** that the upper bracket can lie against the PCB (print circuit board); this will insure optimal contact between the CPU and micro freezer.

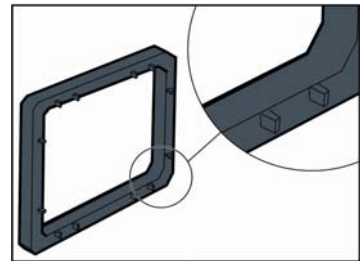

Important: Place extra seal-string around all components that are caught going in under the bracket, to prevent any false air to find its way underneath such component into the hermetic sealed chamber. On many motherboards this is an issue, and if the components are not sealed off, water will build up inside the sealed chamber.

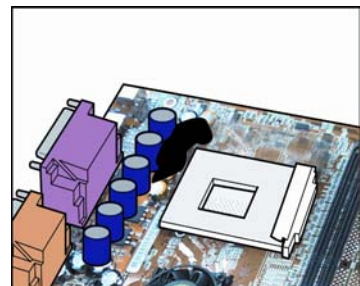

Place **2** layer of seal-string on the bottom side of the upper bracket (the side with the 2,5mm legs), in order to insure proper sealing. Mount the upper bracket, so it surrounds the CPU socket, with the seal-string **against** the motherboard. Make sure to press the bracket firmly against the motherboard, so all the legs touch on the PCB. Before moving further, make sure that there is a tight sealing between the PCB and the upper bracket, if necessary use a finger around the edge, and pres the sealing material against the PCB.

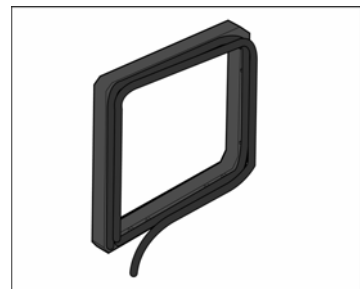

A heating element is mounted inside the Rear cover. Place extra seal string on the edge of the rear cover where the wires come out before sealing the entire edge, this prevents any gap in forming between the wires and the rear cover.

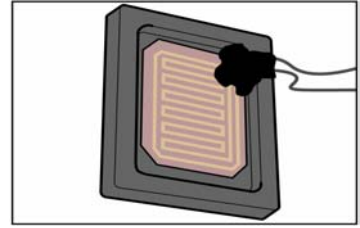

Place Seal-string onto the perimeter of the rear Cover. Firmly press the rear Cover onto the back of the motherboard. Place it so that it will match the position of the Upper bracket that is installed on the other side of the motherboard. It is imperative that they become aligned. Install the motherboard on the PC- mounting plate.

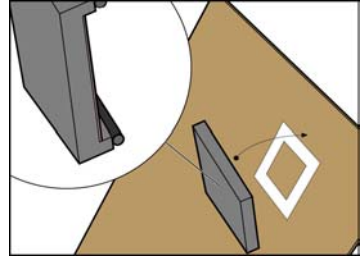

Make sure that the stands on the back plate are located correctly when mounting the motherboard to the back plate.

Mounting the Microfreezer.

After the EasyMod kit has been mounted, it is time to mount the MicroFreezer.

Put a thin layer of thermal compound on the evaporator inside the micro freezer. Press the micro freezer down over the CPU until they have physical contact, and lift it carefully off again to make sure that the evaporator makes a **full surface contact with the CPU Core.**

It is of utmost importance that the evaporator obtains good contact to the CPU core.

The surface of the micro freezer has a small plastic orientation pellet. This pellet must always be located **upside** in the right or left corner to make sure that the micro freezer is mounted correctly.

The micro freezer is designed to be mounted in either one of the 2 directions mention above.

If it is not possible to attach the micro freezer correctly to the mounting bracket – the clips is turned the wrong way. Turn the Clips 180 degrees and try again.

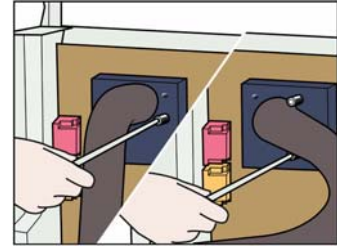
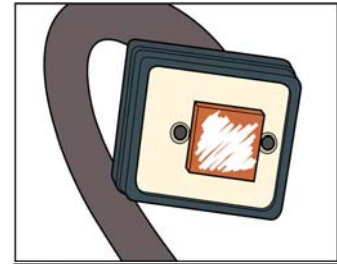

Put a thin layer of thermal compound on the evaporator inside the micro freezer. Press the micro freezer down over the CPU until they have physical contact, and lift it carefully off again to make sure that the evaporator makes a **full surface contact with the CPU Core.**

It is of utmost importance that the evaporator obtains good contact to the CPU core.

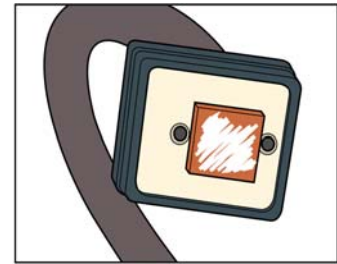

The micro freezer is secured in place with two screws into the clips. The screws must be tightened evenly and almost simultaneously, but only to the bottom of the threaded brass stands – do not over-tighten the screws!

Increased pressure is regulated through the use of extra spacer rings between the screw head and the spring.

To be sure that there is an optimal contact against the CPU, detach the micro freezer and inspect the imprint on the evaporator.

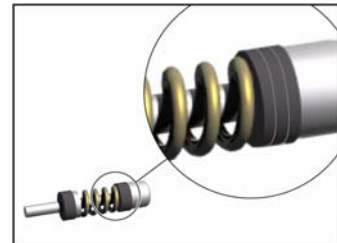

Finally press two small lumps of seal-string down over the screws to seal them off properly and close the last possible entry to the hermetic sealed chamber.

If your motherboard has a protective piece of plastic around the socket, be sure to seal this or remove it.

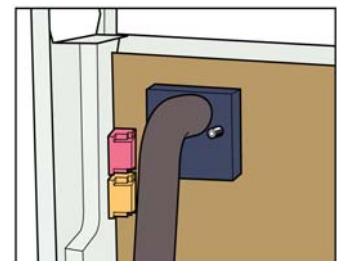

Improving Thermal Contact

If you fail to get a proper CPU imprint on the evaporator, when checking the contact or you are having very high CPU temperature while running at default CPU settings, you will need to improve the thermal contact between the CPU and evaporator.

This section gives a few ways to improve the thermal contact.

Adding extra spacer rings on the two mounting screws.

Be careful that the evaporator is still levelled with the CPU core. (For AMD users, make sure not to add too much pressure on the fragile CPU core)

(AMD) Check that the protective shim isn't resting on any of the CPU's SMD components.

If the shim is resting on some SMD components, then make a cut-out in the Shim.

(Intel) Check that the mounting bracket and rear cover is mounted properly.

Verify that the 4 screws are firmly in place - holding the mounting bracket firmly against the motherboard and resting on the 4 feet. Otherwise the micro freezer cannot be held properly in place.

Check that the thermal bus (the black hose) does not touch any of the sides of the PC chassis.

If the thermal bus is pressed against any of the side in the PC-Chassis or anything else, it might add pressure on the micro freezer causing a small gap between the evaporator and the micro freezer.

Applying the right amount, and type of thermal compound.

Make sure there is only a thin even layer of thermal compound on the CPU core.

Applying thermal compound improperly the temperature loss across the thermal compound would be considerable.

Wait for the evaporator and CPU to reach ambient temperature then clean the evaporator and the CPU, by using acetone or mineral spirits.

Apply a drop of thermal compound in the middle of the CPU core, wrap some plastic around your finger and then rub the thermal compound around the CPU until there is a thin even layer covering the entire CPU core.

NOTE! When you want to change processor, unscrew the micro freezer, and drag it off slowly, but forcefully, while holding the motherboard.

Before removing it, wait for the temperature to reach ambient temperature.

Always be careful when detaching the micro freezer - nVENTIV cannot be held responsible for any destroyed hardware.

Connecting the Wires

Before powering up the cooling system, be sure to connect all necessary wires from the Prometeia chassis to the motherboard, heating element in the rear cover, PSU and the Power switch at the front panel.



There are 5 wires coming from the Chip-controller in the Prometeia chassis. These have to be connected before powering up the system.

1) **Power Cable**

Connect the power cable (yellow black, black and red) to an unused power connector - same as used for the drives.

2) **Heating Element**

Connect the heating element to the connector from the Chip-controller.

3) **Power Switch Motherboard**

Connect the yellow/yellow wire to PWR-switch on the motherboard. The yellow/yellow wire from the Chip-controller will boot the computer when the desired boot temperature is reached. The yellow/yellow wire will also shut down the system when pressing the On/Off switch at the front panel for more than 4 sec. or if any failure occurs.

If this cable isn't connected properly the PC won't start and the cooling system will power down about a minute after reaching boot temperature.

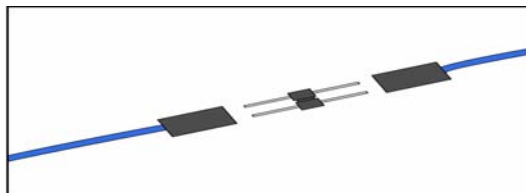

4) **Power Switch PC-Chassis**

Connect the blue/white wire to the On/Off switch wire from the front panel. When pressing the On/Off switch at the front panel, the cooling system starts running - but the computer is NOT turned on.

5) USB CABLE

There is 2 types of USB cables as shown below. The only thing that varies is the color of the wires.

In the examples below we assume you have the USB cable to the left.



or



1. Red (5V) Voltage +
2. White (D-) Data -
3. Green (D+) Data +
4. Black (Ground) Voltage -

1. White (5V) Voltage +
2. Green (D-) Data -
3. Red (D+) Data +
4. Black (Ground) Voltage -

In order to properly connect the Chip-controller to the USB it is necessary to know which USB connection that is available on your motherboard. Please refer to your motherboard's manual, or contact the motherboard manufacturer.

Most motherboard's use 8, 9 or 10 pins connections, arranged in 2 parallel rows.

The examples below, shows how to connect the Prometeia Chip-controller to the USB connection on your motherboard, depending on which type of connection you have on your motherboard.

EXAMPLE 1: 8 pins with 4 pins in each row.

In this case connect the USB connector to either row, just be sure that pin 1 (Red) on the USB connector is connected to pin 1 on the motherboard.



EXAMPLE 2: 9 pins with 5 pins in the 1st row and 4 pins in the 2nd row.

Like in the example above it is possible to connect the USB connector to either row.

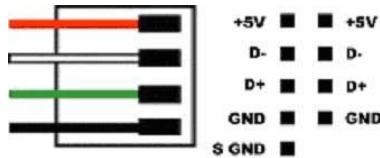

EXAMPLE 3: 10 pins with 5 pins in each row.

Here it's also possible to connect the USB connector to either row, as long as pin 1 (red) matches pin 1 on the motherboard.

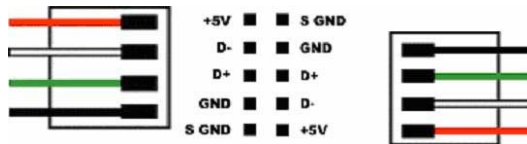

Once the USB cable has been connected properly, the "Prometeia" device should be located under the hardware device manager. (Right click on my computer, chose properties, select device manager).

If there are any problems finding the device in Windows, try a different USB connector on the motherboard, if any is available, or a different row on the current connector.

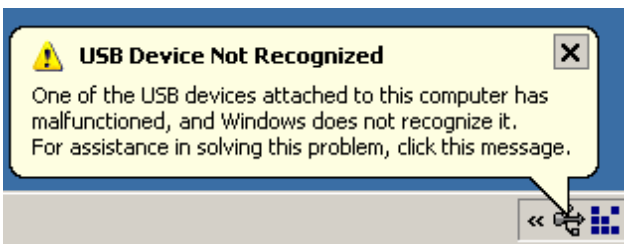

A common error when connecting the USB-cable on the motherboard is to attach the cable in reverse position – the picture will appear in Windows XP when the cable is attached in reverse.



If the error: "USB connection failed - unable to run program" appears you have encountered a software related error and you should replace the original PCC.EXE file with the updated PCC.EXE. Go to the [Download section](#) of nVENTIV.com. This option is functional the 16/10/03

Installing the Software

The software is used for communication between the user interface in Windows and the Chip-controller. The software supports Windows 98, Me, 2000 and XP.

Installing the Prometeia USB driver.

Once the USB Connector is plugged correctly onto the motherboard and windows have found and recognised the Prometeia Chip Controller. The "New Hardware Found" box will appear.



Click Next to get to the following page.



Insert the CD-ROM which came with the Prometeia and click next to finish installing the Prometeia USB Drivers.

In case windows does not automatically detect the new hardware, open the control panel and select add new hardware.

Click next on the dialog to start searching for new hardware.

When new hardware is found - then follow the same procedure as above.

If no new hardware is found, recheck your USB connection on the motherboard or try to use another USB motherboard connector.

Installing the Prometeia Control Centre.

Insert the CD-ROM which came with the Prometeia and open the setup file.

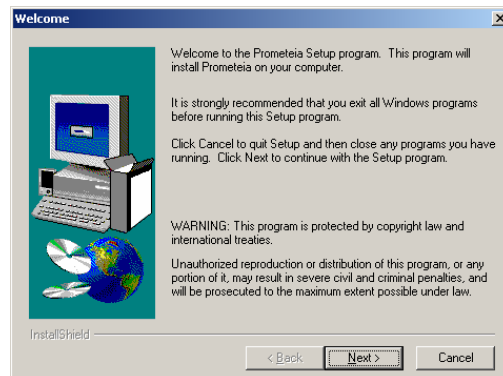

Click Next.

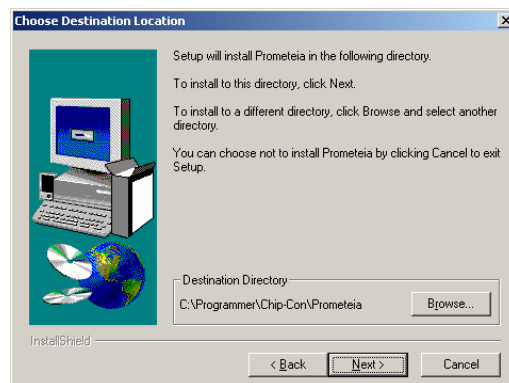

Choose the installation path and click Next.

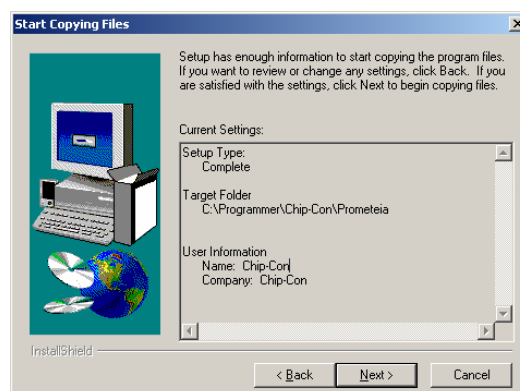

Click Install to start installing the software in the chosen directory.

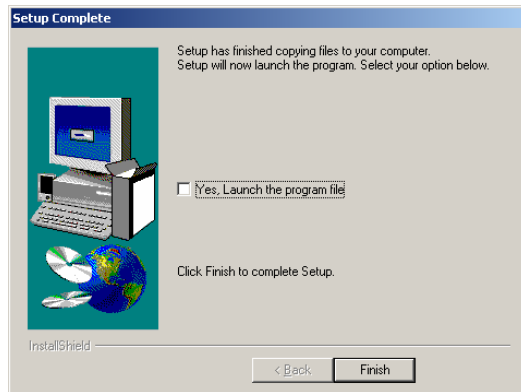

The Prometeia Control Centre is now installed on the computer, click finish to close the install program.

Start the program by click on the Prometeia Control Centre now located under programs in the start menu.

When reinstalling the software, then completely remove the old version before moving further. Open the device manager and uninstall both the Prometeia and Windriver devices. Then open the control panel and double click on the add/remove program icon. Locate and uninstall the Prometeia software.

Note: In some versions of Windows 98 the CPU LOAD field in the Prometeia control centre fails to read the correct CPU load.

When upgrading the firmware, get the latest firmware file from nVENTIV.

Open the folder where you have installed the Prometeia software and run the Bootloader application.

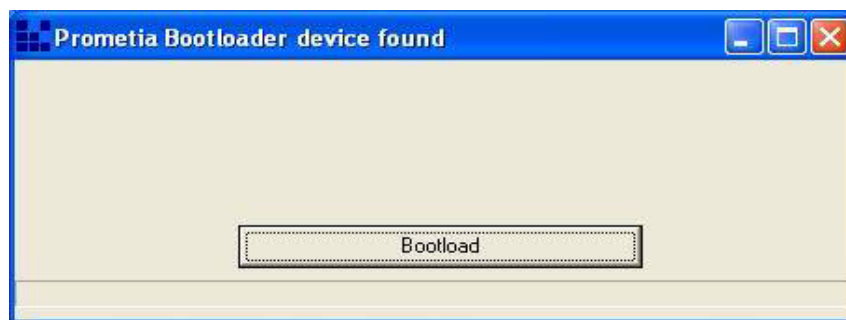

Click on the bootload button and selected the proper .ste file to replace the current program in the chip controller.

New updates will be available on our web-site.

Before bootloading verify that you have the newest software to upload into the chip controller, or you might risk ending up with an unstable system.

Caution: DO NOT turn off the computer (or close the bootloading application) while upgrading the firmware, but wait until upgrading is finished.

ADD-ON PRODUCTS

Top-chassis – Lian Li or Enlight.

Mounting the PC -Top chassis.

In order to mount the PC-Chassis on top of the cooling system you will need a pre-made chassis or to modify the chassis on your own. When mounting the Prometeia cooling system to hardware, the hardware has to be mounted in a top-chassis which is attached above the Prometeia chassis.

The top of the Prometeia chassis has 4 holes with threads (6mm) for mounting the top-chassis (see illustration below).

Please refer to the illustrations below for making the modifications for the 4 screws and for the thermal bus in the top-chassis.

(Prometeia chassis - matching Enlight EN-7238)

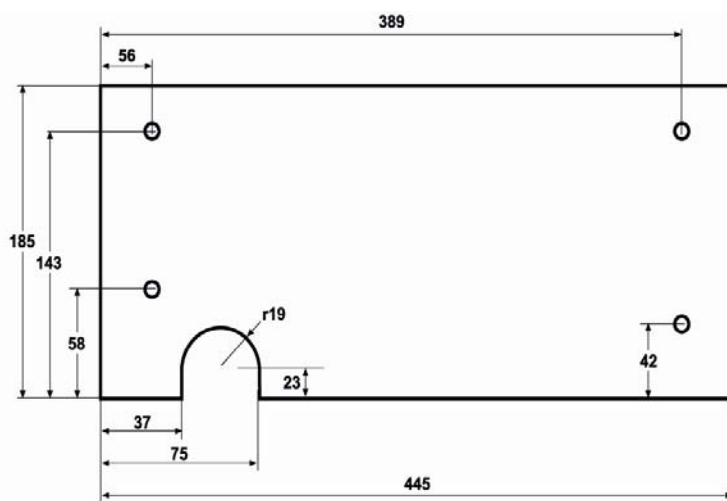

(Prometeia chassis with Alu-Kit - matching Lian Li PC-60)

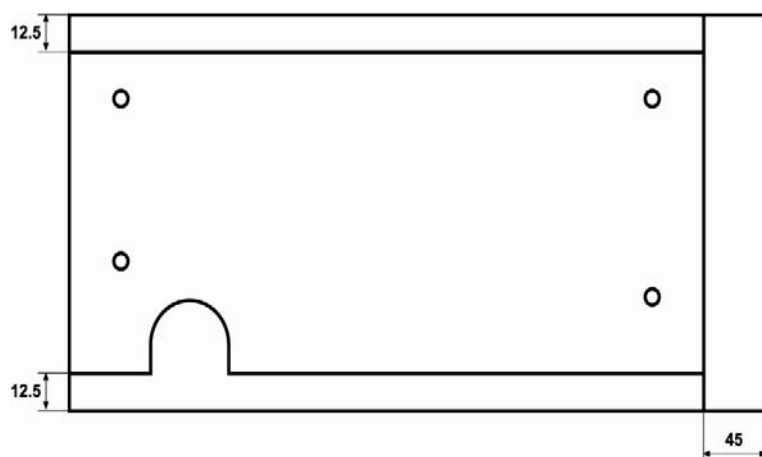

After making the screw holes and the cut-out for the thermal bus, the PC-chassis needs to be cleaned for metal pieces and the edge of the cut-out has to be evened out to prevent damaging the thermal bus.

Place the PC-chassis on the top of the cooling unit so that the holes are aligned and then fasten the 4 bolts.

Installing the Aluminium kit.

This instruction guide is for authorized personal only, in order to guide through the installation of the Alu-Kit for the Prometeia cooling system. Private individuals may under no circumstances remove the side panels!

Before installing the Alu-kit, make sure all main connections to the cooling system has been detached.

Step 1

Detach the old side panels and clean the sides where the aluminium profiles for the Lian-Li kit glue on to the chassis of the Prometeia.

Step 2

Before commencing with the actual assembly, make sure that the Prometeia chassis is standing 100% even and upright with 90 degree angles in all directions. Doing this will ensure optimal fitting.

Step 3

Attach the two front profiles no. 1 which glues on to the front side of the Prometeia chassis (remove the yellow protective film), where after you snap on the actual front bezel no. 2. The first series Prometeia chassis needs two modified front profiles, please contact nVENTIV for such profiles.

Step 4

Take the side panels no. 5 and peel off the protective film that protects the outer surface. Place the short aluminium profile no. 3 at the back rear of each of the side panels on the inner surface. Make sure it is aligned with the rear edge of each panel. (Please note that the 3 screw holes have different positions in each end of the side panel. If the profiles don't align correctly, you have placed it in the wrong end of the panels.

Step 5

Fix the profiles to the panels with the screws provided.

Step 6

Take the long aluminium profiles no. 4 and place them at the top and bottom of the side panels, pushing them up against profile no. 3 for a snug fit. Then fix them to the panels with the screws provided.

Step 7

Remove the yellow protective film from the glue strips on the aluminium profiles and glue the side panels onto the Prometeia chassis. Hold each side panel against the front profiles (no. 1) that are already attached to align the height positioning. Now swing the rear end of the side panel onto the chassis keeping the front edge of the panel pivoted against the front bezel. This action should work like a door, ending with a properly aligned side panel stuck to the chassis. Make sure the remaining front screw holes in the panels align with the front profiles no. 1.

Step 8

Detach the side panels and cut the "black foam" no. 6 in "small" pieces and place the pieces around on the aluminium profiles. Afterwards mount the side panels. This will avoid any vibration from the cooling unit to cause unnecessary noise.

Step 9

Drill the four holes and make the cut-out for the thermal bus in the Lian Li chassis by using the shape attached in the Kit (*if the shape dos not match your Prometeia chassis please contact nVENTIV for further assistance*). But first drill out the 2 rivets at the front of the drive-bay mounting bracket in the Lian Li chassis. When attaching the two chassis together the drive-bay mounting bracket will be tighten with the bolt to the Prometeia chassis. Please make sure that the shape is placed correctly on the bottom of the Lian Li chassis. Remember to dismantle the four rubber feet at the bottom of the Lian Li chassis. The white plastic included in the Kit is for mounting on the cutting edge of your Lian Li chassis.

Step 10

Mount the top chassis on the Prometeia chassis, and remember to place the four rubber spacers included in the Kit between the two chassis at the four drilled holes.

Step 11

Let the chassis rest for a while, allowing the glue to cure properly between the two surfaces; this will insure a very strong bond between the two surfaces.

NOTE: Remember to detach the front bezel when transporting the cooling unit. Detaching the front bezel is done by removing the front bezel from the bottom and outwards!

Explode view

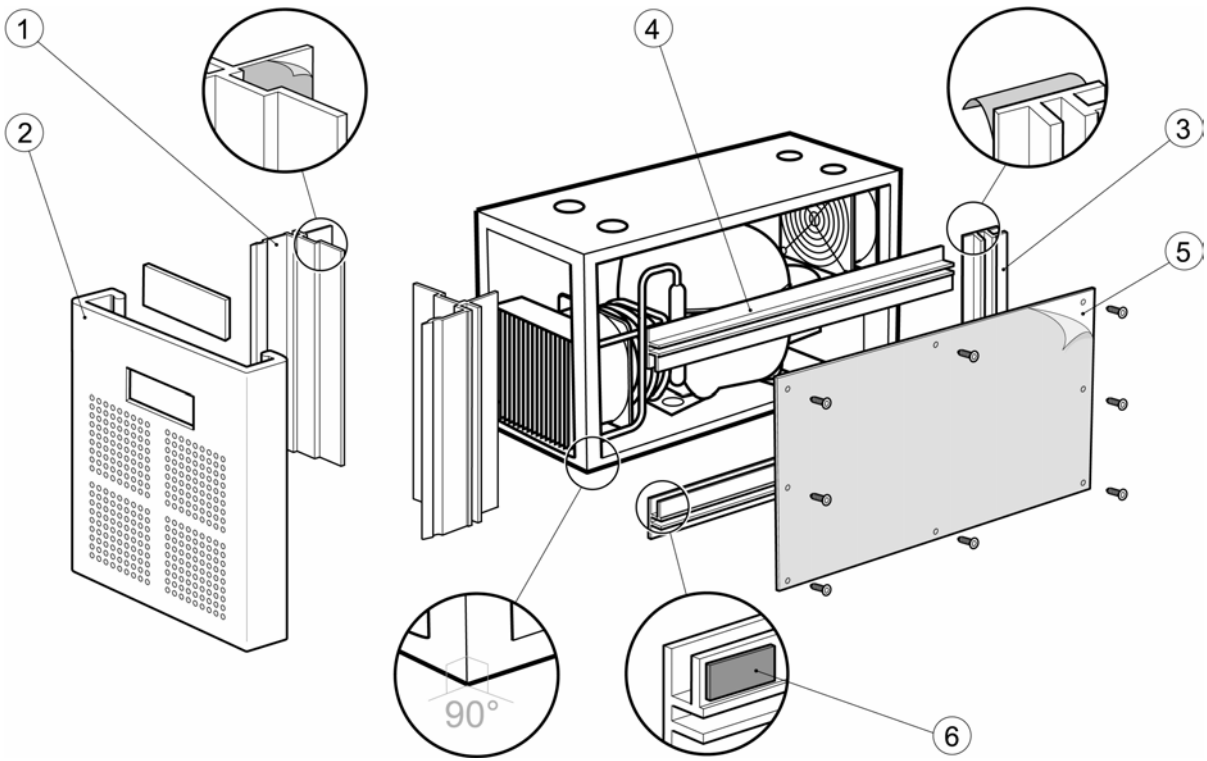

Mounting front bezel and side panel to the chassis

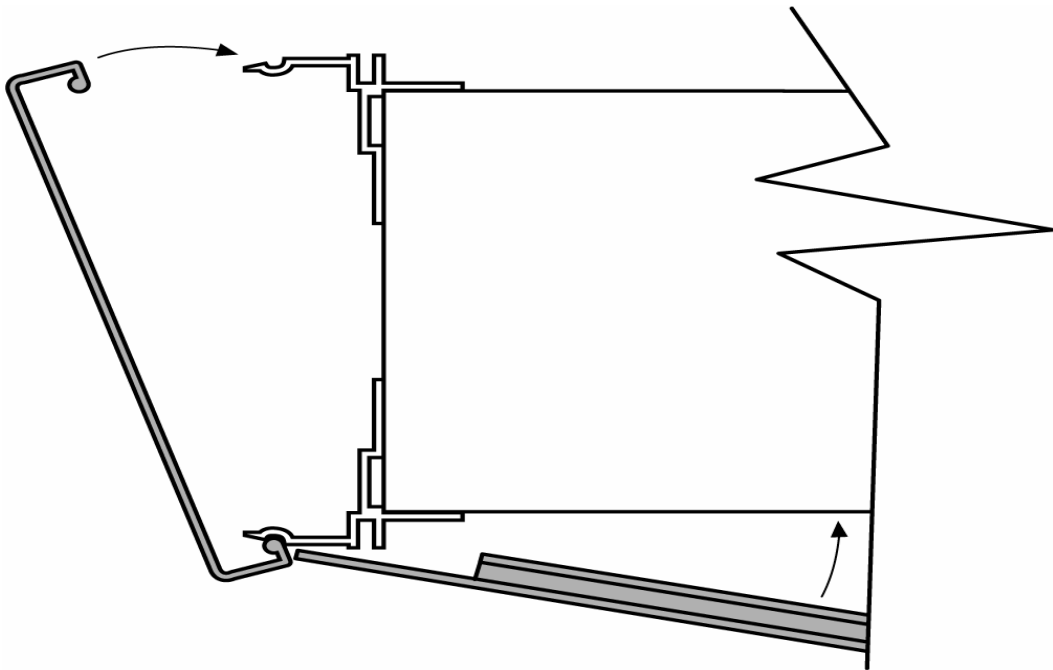

Installing the Display

This instruction guide is for authorized personal only, in order to guide through the installation of a display for the Prometeia cooling system. Private individuals may under no circumstances remove the side panels!

Before installing the display, make sure all main connections to the cooling system has been detached.

The **Display-KIT** consists of the following components:

- Display.
- Wire for the display
- 4 screws (M2,5 x 16mm) and 4 stands with a length of 7,5mm. For **Enlight chassis** use the 4 small screws and stands when mounting the display to the Prometeia chassis.
- 3 screws (M2,5 x 40mm) and 3 stands with a length of 30,0mm. For Lian Li PC 60 chassis or similar use the 3 long screws and stands when mounting the display to the Prometeia chassis.

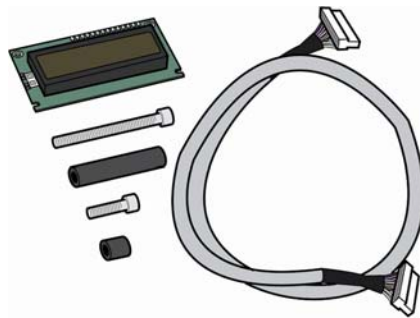

Step 1

Detach the left side panel of the Prometeia chassis (looking from the front of the chassis).

Step 2

Attach the display-wire to the Chip-controller 16 pined connector. The display wire can only be attached one way.

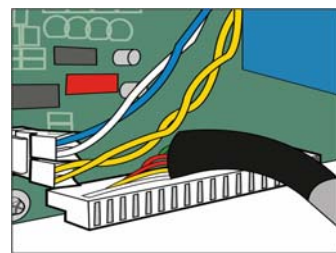
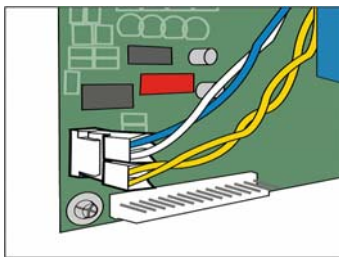

Step 3

Place the display-wire along the side of the chassis; use the holders to secure the display-wire to the chassis.

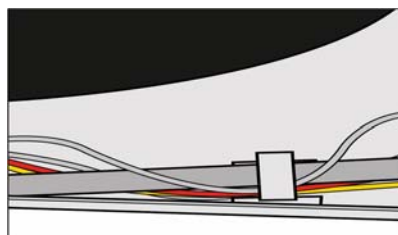

Step 4

Let the display-wire come upwards beside the condenser and out of the hole between the condenser and the chassis.

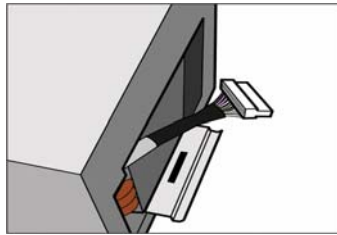

Step 5

Attach the other end of the display-wire to the displays 16 pined connector – the display-wire can only be attached one way.

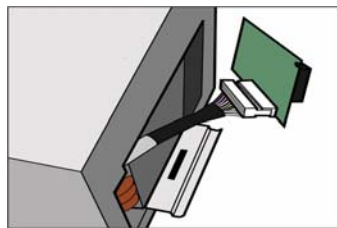

Step 6

Mount the display onto the Prometeia chassis; mount the stands between the chassis and the display.

For Enlight, use the 4 short stands and mount the display a little left from center of the chassis – fits the center of the glass of the Enlight cover.

For Lian Li, use the 3 long stands and mount the display in of the center of the chassis - fits the center of the glass of the Enlight cover.

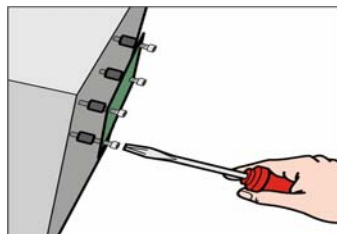

Step 7

When the display is attached then make a cut out in the foil mounted on the display glass, ensuring the foil to cover the two "open spaces" beside to the display – one piece of foil with a width of 18mm and another of 21mm.

When looking from the inside of the front bezel, the foil with a width of 18mm is on the right side of the display glass and the other is on the left side.

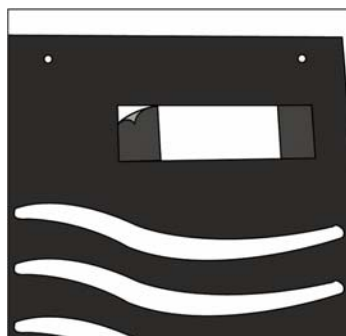

Troubleshooting

Alarm Conditions, Causes and Remedies

In the event of an alarm, the red diode (4) will start to flash and the function of the light diodes (1, 2 and 3) is altered. Light diodes 1, 2 and 3 can afterwards be coded binary to indicate the failure that has occurred – starting from diode 1 (1 binary) to diode 3 (4 binary), thus a failure condition is given a number from 0 (no diode is flashing) to 7 (all diodes is lighting).

Error code	Description (Indication in the Display)	Cause	Remedies
0	To Slow.	The motherboard does not power on within a given time	Contact nVENTIV for further assistance
2	To Hot.	System failure	Contact nVENTIV for further assistance
3	HOT STOP	System failure	Contact nVENTIV for further assistance
4	Fan failure. If a Display is connected, it will indicate which Fan is defect.	The fans cannot turn or bad connection to the Chip-controller.	Contact nVENTIV for further assistance
5	Fail sensor. If a display is connected it will indicate which sensor is defect.	The sensor is broken or bad connection to the Chip-controller.	Contact nVENTIV for further assistance
6	No Shut down	The PC has not been shut down (dead lock). The compressor continues to cool.	Turn of the PC manually and verify that the yellow wire from the cooling unit is connected properly to the motherboard. Contact nVENTIV for further assistance
7	Cooling fault	The bimetal is open. To high condensation temperature.	Make sure that the airflow through the system isn't blocked and that the condenser is cleaned for dust. Contact nVENTIV for further assistance

Problems

The table below shows some possible errors that might occur in the system and how to solve these problems.

Problem	Cause	Remedies
The cooling unit does not cool at all	Power wires not connected correctly.	Check that all wires are connected correctly.
No picture on the monitor once the computer boots up	System overclocked too much or some of the hardware not installed correctly.	Try unplugging the ATX connector and clear the CMOS, also check that all hardware are installed properly.
The cooling unit reaches -33 degrees but the PC does not start	Power supply turned off or the yellow cable to the motherboard not connected properly.	Check that all wires are connected correctly and that the power supply is switched on.
Can't establish a proper connection between the software and the Chip controller via. USB	Drivers not installed correctly or USB cable connected incorrectly.	Uninstall all Prometeia drivers and software and follow the steps in the USB and software section in this manual. If it still fails contact nVENTIV for a new firmware.
The computer restarts once you try to access the BIOS menu	It seems that a few motherboards resets when you try to access the BIOS menu when the CPU is below zero degrees.	Please refer to the motherboard's manufacture and get a BIOS upgrade. Until then you will have to use a normal air cooler, change the BIOS settings, and then remount the Prometeia.
The PC often freeze or resets by itself when using windows	Bad thermal contact or system overclocked too much.	Check that there is good contact between the CPU and the evaporator, if there is perfect contact; try lowering your FSB or check RAM timings.
The cooling system doesn't start when I press the power button.	Main power turned off or blue/white wire from PC-Case front panel On/Off switch is not connected properly to the Chip-controller.	Check that there is power to the cooling system, and that all cables are connected as described in the section "connecting the wires"
"USB connection failed - unable to run program", appears when connecting to control center.	It is a software related error.	Replace the original PCC.EXE file with the updated PCC.EXE. Go to the Download section of www.nVENTIV.com
The computer boots properly but shuts down a little while after.	The CPU temperature is to high.	Check that the contact between the evaporator and the CPU.

FAQ

The table below contains answers to most common questions we receive from our customers.

Question	Answer
Can I assemble the Prometeia myself?	Yes you can. It is as easy as mounting a regular heatsink.
How big a performance boost will I achieve with the Prometeia?	Hard to say. The normal boost is between 30 and 50%. But this may vary as a result of the hardware being used.
Can I upgrade my CPU, once the Prometeia has been assembled?	Yes. All the hardware in your Prometeia, including the CPU, can be upgraded.
How much do you cool the CPU?	The Prometeia cools to approximately -50 degrees Celsius. The CPU operating temperature is between -10 and -35 degrees Celsius depending on the CPU workload.
The side panels on the cooling unit gets very hot, do I have a bad airflow in the chassis?	If the compressor has to remove a lot of heat from the CPU it can get rather hot, causing the temperature to increase in the entire bottom chassis. This is not uncommon and shouldn't cause any problems (there is even a thermal sensor located on the hottest places inside the cooling unit that will shut down the system if temperature exceeds 100 degrees Celsius). Changing the fan speed will affect the temperature in the bottom chassis. If you have been running the system for long especially in a dusty environment cleaning the fans and condenser might also help. This is described in the manual under the maintenance section.
Can I use my own chassis with your cooling unit?	Yes, you can use most chassis with our cooling unit. So if you are able to make a cut-out for the thermal bus (the black hose) in your own PC-chassis, you can use almost any chassis you prefer. See the mounting the PC-chassis section.
The top of the Microfreezer gets rather warm during operation. Is this normal?	Yes, this is perfectly normal. The Microfreezer has a built in heating element, which makes sure no condensation will form on the outside surface either, where free ambient humid air would otherwise source this process. It can get up to 50-60 degrees C.
Can I mount a Peltier element (aka. TEC) between the CPU and the evaporator?	No, this is not possible. Mechanically there is no space for a TEC below the Microfreezer. Besides, the efficiency of a TEC is greatly reduced at low temperatures, so you would probably end up with a higher CPU core temperature than without the TEC.
I want to use the Prometeia base unit and attach it to a Chieftec full tower. Will the capillary tube etc reach the motherboard in a full tower?	If the motherboard is mounted in the same distance from the bottom of the chassis, and oriented as defined in the ATX specifications, there shouldn't be any problems using a different chassis on top of the cooling unit.

<p>The hole in the clip is not centered 100% over the P4 CPU which means a small part of the freezer is not making contact with the P4 heat spreader. Is this normal and what effect can it have?</p>	<p>Since the CPU Core on a P4 is covered with a copper heatspreader, it doesn't matter if the evaporator doesn't make full contact with the entire heatspreader. If the evaporator goes over the middle of the heatspreader, all is well and won't affect the cooling at all. (See the part about Thermal Contact in this Service Manual).</p>
<p>CPU Temperature shows 10-30 degrees Celsius, shouldn't it be below zero?</p>	<p>There are usually 2 reasons for such a high CPU temperature.</p> <ol style="list-style-type: none"> 1) The thermal diode on the motherboard are unable to get a correct reading on subzero temperatures, so it reports an incorrect temperature. 2) Bad contact between the CPU and the evaporator. (See the part about thermal contact in this Service Manual).
<p>Which power supplies can be used with Prometeia?</p>	<p>The compressor itself is powered from the main supply, so it uses almost no power from the power supply. The Chip-controller, 2 low noise fans and heating elements is driven from the PSU, and this represent a workload of app. 1.5A However if you plan on heavily overclocking your system, you CPU will burn a lot more power and you may need a more powerful PSU (power supply unit) to handle the additional CPU load. In this case we recommend at least a 450W quality PSU.</p>
<p>Will you support new CPU releases like the AMD Athlon64 CPU?</p>	<p>Basically we have 3 target groups with our system.</p> <ol style="list-style-type: none"> 1) Those who wants the fastest possible system. 2) Those who wants stability above all in a non overclocked system. 3) Those who want to save money by buying a cheap CPU when they upgrade and then make it run as fast as the best CPU you can buy. <p>In order to keep supporting these 3 groups we have to constantly improve our system and make changes supporting new hardware releases. We are planning on supporting future CPU's as well, making sure when upgrading to a newer CPU type like the Athlon64 (hammer), all you need to buy is a new CPU kit and not a whole system.</p>

<p>Will I void my warranty if I add a plexiglas window in my cooling unit?</p>	<p>Any modification to the Prometeia will void your warranty.</p>
<p>When overclocking my system I can only overclock it 25%, why can't I get a better performance with the Prometeia?</p>	<p>There could be several reasons why you are unable to get a higher performance. A few CPU's are simply of such a bad quality that they can't be accelerated more than a few MHz no matter how cold it gets. Your other hardware might also be the limiting factor, if you use older RAM or motherboard, it's quite possible that they won't be stable at higher FSB's. See how much you can gain with standard cooling, and then compare it to the results you get with the Prometeia. If you can't get much more out of your CPU with the Prometeia, you might want to check your BIOS settings or upgrade some of your other hardware.</p>
<p>Can I change the gas in the Prometeia?</p>	<p>We wouldn't recommend this, as the system is designed to run on 134a. This would also completely void your warranty and would require some additional modifications of your system.</p>
<p>Can I change the fans in the Prometeia?</p>	<p>We recommend that people don't open the cooling unit, for own safety, as this gives direct access to main voltage, and also voids warranty. Exchanging the fans with less powerful ones could affect cooling performance.</p>
<p>How much can you bend the thermal bus without risk breaking it?</p>	<p>You should under no circumstances bend the thermal bus outward (away from the PC-chassis) and if you need to bend it, do it as high on the thermal bus as possible, and in soft wide curves - no sharp bends.</p>
<p>If the compressor suddenly stops, will my CPU be destroyed or is there any safety build into the Prometeia.</p>	<p>There are several safety mechanism build into the Prometeia, that will turn of your motherboard should the temperature get critical.</p>

Appendix A

Maintenance

Like any PC with fans, your Prometeia cooling system also needs a bit of maintenance in order to continue to cool your PC properly. Unplug the power cord, but do **NOT** take off the side panels of the cooling unit. There are no user serviceable parts inside.

Turn off the unit and remove the front bezel of the cooling unit. Using a standard household vacuum cleaner, clean the condenser in vertical movements only, taking care not to bend any of the fins. Likewise you can also clean the air-outlet on the rear of the cooling unit, as well as the air-outlet from the PC-Power supply, to remove dust from the rear grills and fans.

Depending on your environment it is recommended, you perform this simple maintenance at least once a month, in very dusty environments perhaps twice a month.

Tests

If you are having problems with the cooling system you can perform this small test to check if cooling system works at all.

Dismount the MicroFreezer from the motherboard, and unplug the power switch cable from the motherboard (leave the one from the PC-chassis connected to the cooling unit).

When you press the power button, the display turns on, and the fans as well as the compressor starts up. After about 3 minutes the evaporator should start to get cold, watch the display and check that the system cools down to -33 degrees (unless the boot temperature has been changed), it should then go from "Activated" to "Running".

TECHNICAL SPECIFICATIONS

Model Name.	Prometeia Mach II
Power requirements	200 - 240VAC 50Hz 100 - 127VAC 50 - 60Hz
Compressor power consumption	130W (Idle)
Cooling capacity and fans at normal speed.	0 - 200 Watt @ -50 to -20°C, at 22°C ambient temperature
Operating environment	15° - 30° Celsius, max. 95% humidity
Noise-level	3 db (A) under normal operation 39 db (A) during start-up
Cooling unit only	280 x 590 x 430mm (W x L x H) 11,0" x 23,2" x 16,9"
Weight	(G.W.) 19,5 Kg. 43,3 lbs.

Contact information

nVENTIV A/S Majsmarken 1 9500 Hobro Denmark	www.nventiv.com
Tel: +45 72 40 15 25	Support Department support@nventiv.com
Tel: +45 70 27 22 12 Fax: +45 70 27 22 13	Sales & Marketing Department sales@nventiv.com